

SPICE thermal model

BUK9M53-60E

Symbol	Parameter	Conditions	Min	Typ	Max	Unit
$R_{th(j-mb)}$	thermal resistance from junction to mounting base		-	-	4.17	K/W

C_{th1}	9.782E-06 F
C_{th2}	9.797E-05 F
C_{th3}	5.849E-05 F
C_{th4}	1.642E-03 F
C_{th5}	4.431E-04 F
C_{th6}	4.924E-03 F
C_{th7}	7.792E-02 F
C_{th8}	6.763E+01 F
R_{th1}	6.862E-03 Ω
R_{th2}	1.289E-02 Ω
R_{th3}	1.003E-01 Ω
R_{th4}	7.651E-02 Ω
R_{th5}	1.956E+00 Ω
R_{th6}	1.631E+00 Ω
R_{th7}	3.775E-01 Ω
R_{th8}	5.465E-03 Ω

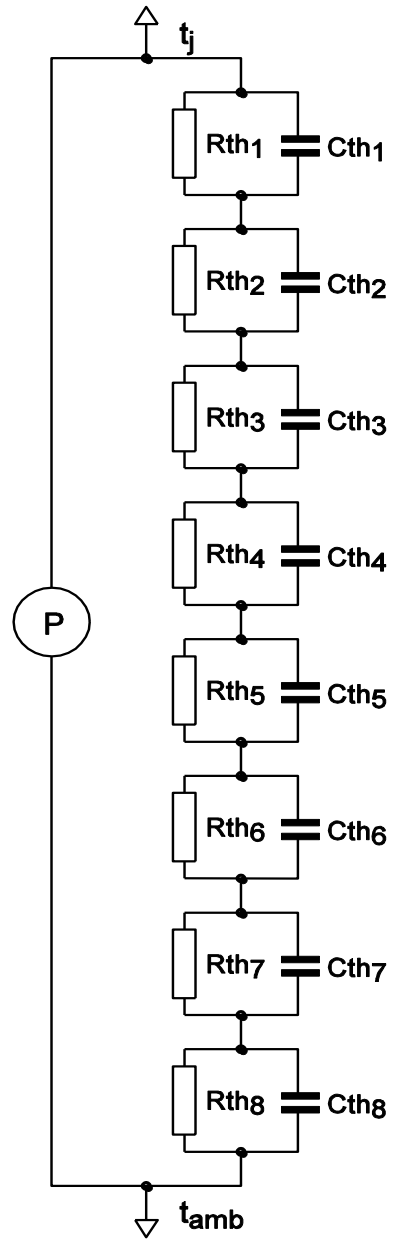

Part: BUK9M53-60E
 Date: 3/3/2016
 Model Rth 4.17 K/W